

QUICK GUIDE

For more product details, please visit
www.surveillance-download.com/user/m521.swf

PACKAGE CONTENTS

Before starting to set up your camera, please make sure items below are in your box:

Standard package:

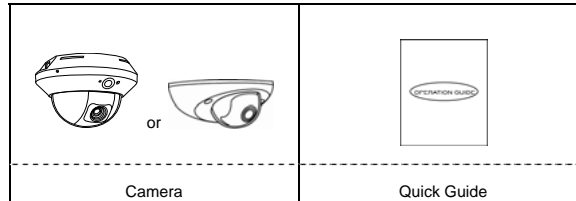

Optional accessories:

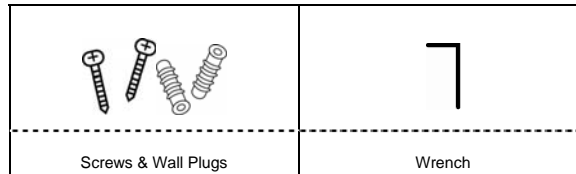

Camera Overview

Type 1

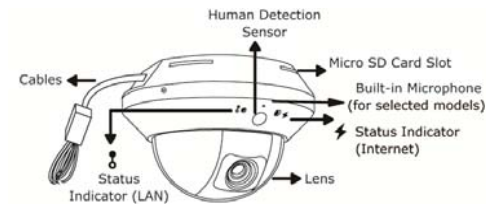

Side View (depending on the model you use)

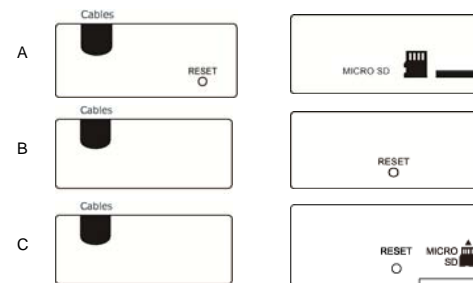

Type 2

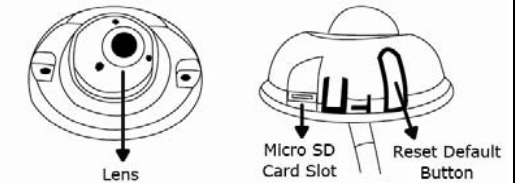

INSTALLATION

Type 1

- Step 1: Separate the dome cover from the camera.
- Step 2: Make sure the screw holes on the plate are aligned with the holes on the camera base. If not, slightly loosen the two screws on the plate and rotate it.

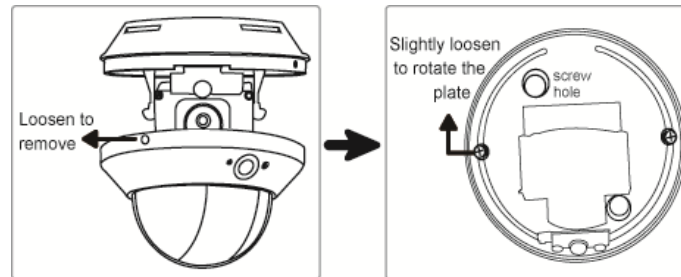

- Step 3: Mark the locations of the two screw holes on the ceiling or wall, and drill a hole for each on the ceiling or wall. The distance between your camera and the location you want to monitor should be 3 ~ 4 meters.
- Step 4: Fix the camera to the ceiling or wall with the supplied screws.
- Step 5: Connect your camera to power.
- Step 6: Pan, tilt and rotate the lens itself to adjust the position and viewing angle of the camera, and fasten the two screws on the plate to fix.

Note: You don't need to manually pan the type with motorized pan.

Step 7: Replace the dome cover back to the camera.

Note: Please wipe the inner part of the dome cover against the lens for clear images.

Type 2

- Step 1: Separate the dome cover from the camera.
- Squeeze two sides of the dome cover as located and indicated below, and move it upward to remove.
- Step 2: Place the camera to where you want to install, on the ceiling or wall, and mark the points for screws.
- Step 3: (Optional) When the cable is arranged to walk along the wall, find and cut as indicated below to let the cable out.
- Step 4: Fix the camera to the ceiling or wall with the supplied screws.
- Step 5: Connect your camera to power.

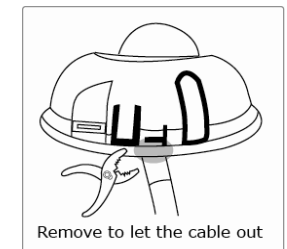
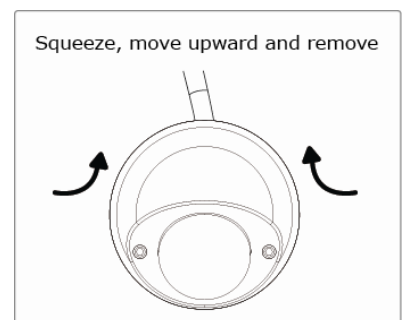

■ INSTALLATION (Continued)

Type 2 (Continued)

Step 6: Pan, tilt and rotate the lens to adjust the position and viewing angle.

To rotate the lens, it's recommended to use the supplied wrench by inserting it to any of the three holes on the lens.

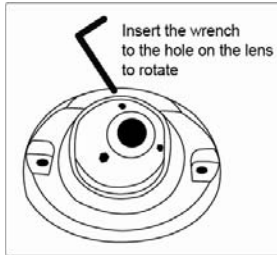

Note: The rotation angle of the lens is not 360°.

When rotating the lens, do not force the lens to rotate when you feel resistance. Also, please leave the focal length the way it is. The default is already the optimum.

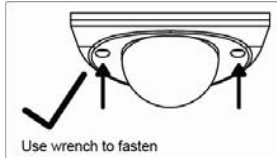

Step 7: Replace the dome cover back.

Note: Please wipe the inner part of the dome cover against the lens for clear images.

Step 8: Fasten the cover screws as indicated below.

■ Insert MicroSD Card (For selected models)

The data originally saved in the microSD card (if any) will be removed after inserting it to the camera.

The camera doesn't support hot-swapping. Please insert or remove the microSD card with power disconnected.

Please follow the directions in the below graphic to insert microSD card properly:

Type 1



Type 2

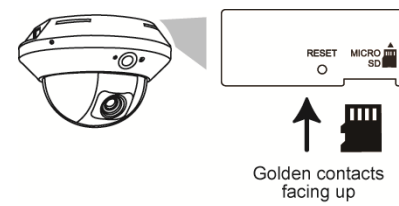

Type 3

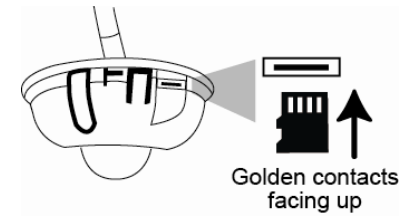

■ CAMERA CONFIGURATION

For advanced configuration of your camera, please be sure you have connected your camera to NVR as shown below:

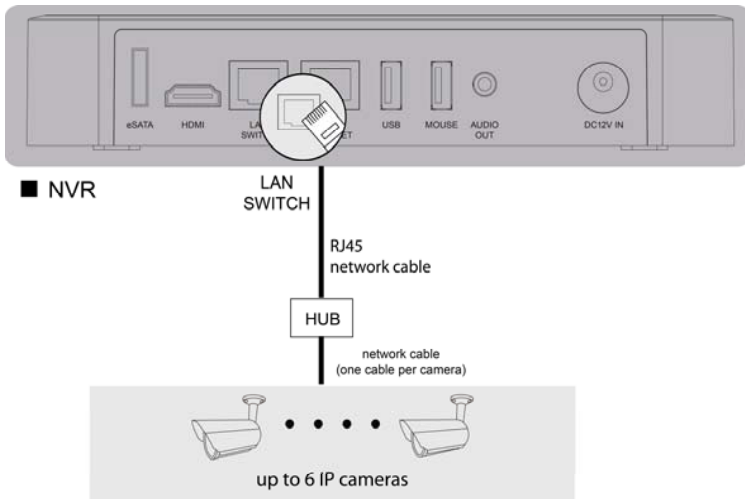

Step 1: Connect PC to the HUB connected to your camera(s) with RJ45 network cable.

Step 2: Search available devices with "IPScan.exe"; to download "IPScan.exe", please visit www.surveillance-download.com/user/IPscan.zip

Step 3: After searching, set your PC in the same network segment as the specific camera you want to access, such as "192.168.30.xxx" (xxx could be 0-255) in our example

IP	Port	Type	Mac	
192.168.30.1	88	IP CAMERA (FIX)	00:19:94:25:78:4f	Configure
192.168.30.1		IP CAMERA (FIX)	00:18:94:25:77:4f	Upgrade
192.168.30.4	88	IP CAMERA (FIX)	00:17:94:25:76:4f	Scan
192.168.30.5	88	IP CAMERA (FIX)	00:16:94:25:75:4f	
192.168.30.6	88	IP CAMERA (FIX)	00:15:94:25:74:4f	
				Exit

Step 4: Note down the IP address and port number of the camera you want to access, such as "192.168.30.1" and "88" in our example.

Step 5: Open Internet Explorer on the PC, and enter the IP address and port number in the URL column to access the camera. The format is `http://ipaddress:portnum`, such as `http://192.168.30.1:88` in our example.



QUICK GUIDE

For more product details, please visit
www.surveillance-download.com/user/m521.swf





Package Contents

Before starting to set up your camera, please make sure items below are in your box:

▼ Standard package:

	
Camera	Quick Guide

▼ Optional accessories:

			
Screws, Wall Plugs, Rubber Rings (x3)	Wrench	Desiccants (x2)	metal rings (x3)

Installation

Step 1: Uncover the dome camera by loosening the three screws on the housing with the supplied wrench.

Note: The three screws aren't designed to be removed from the housing.

Step 2: Attach the supplied installation sticker to your desired installation location.

Step 3: Locate the three deepest holes on the base. (See Pic 1.) They are where the three supplied screws belong.

On the sticker, make holes where the three screws and the cables are supposed to penetrate. However, if the cables won't go through the surface, you don't need to make the hole for them in advance.

Next, align the camera with the sticker, putting the three screws through the holes, as well as the cables—if necessary. Then, tighten the screws.

Note: Put the screws through both the rubber rings and metal rings (optional), then into the holes. (See Pic 2.) To be on the safe side, it is recommended that you be assisted with installation, considering the camera is heavy.

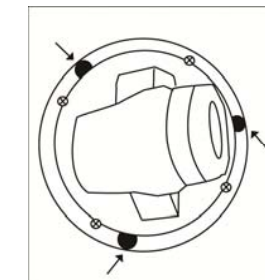

Pic 1

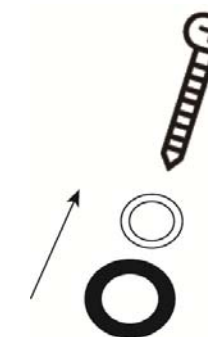

Pic 2

Installation (Continued)

Step 4: The lens can be adjusted in three ways:

a. Loosen the four screws on the plate, along with which you, in turn, can pan the camera.

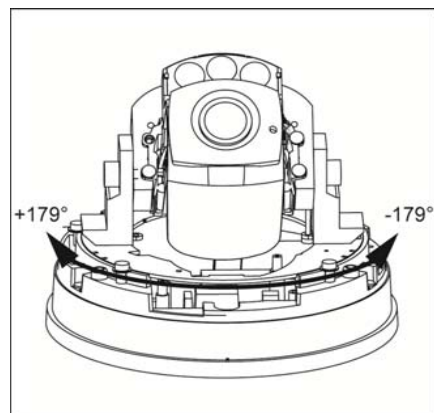

Pan

b. Tilt the lens after loosening the two screws on either side of the lens.

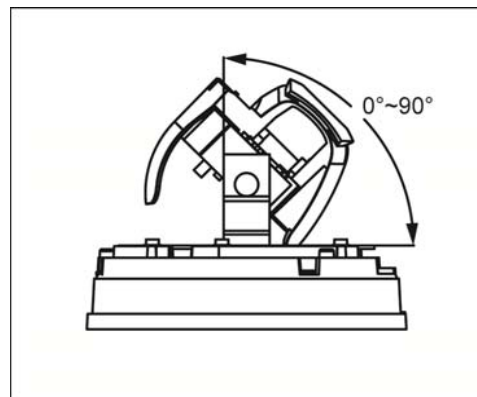

Tilt

c. Remove the protective case by loosening the two screws on it before rotating the lens from behind.

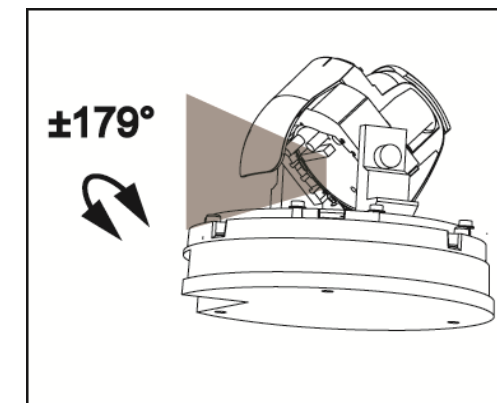

Rotate

Installation (Continued)

Step 5: Be sure to replace the original desiccant(s) with the new ones. Use provided double-sided tape to stick the desiccants in place as illustrated below. Keep them inward enough for the housing to close nicely. The new desiccants must not be exposed to air for over 30 seconds.

Note: Both the two new desiccants are to be put in the camera to remove excessive humidity and ensure the camera works well.

Step 6: Then, clear the lens of fingerprints and replace the housing before tightening the screws on it.

Step 7: Power up the camera.

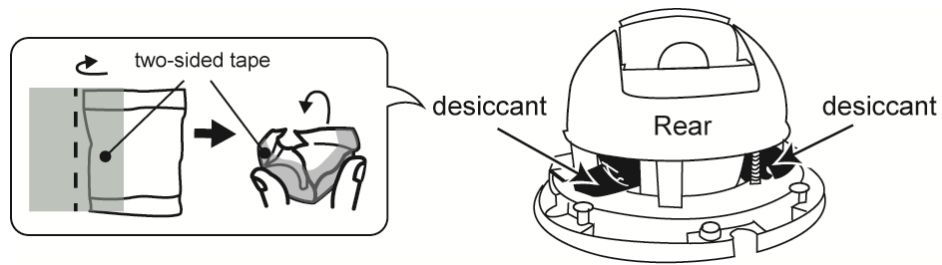

Focusing the Camera

If you need to adjust the focus, the picture below shows you how:

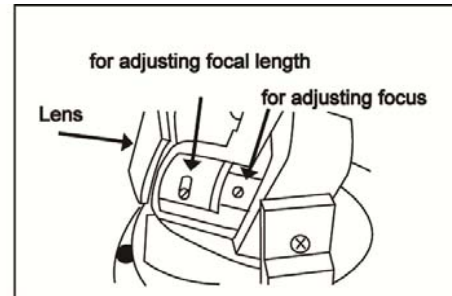

Inserting MicroSD Card

The data originally saved in the microSD card (if any) will be removed after inserting it to the camera.

The camera doesn't support hot-swapping. Please insert or remove the microSD card with power disconnected.

Please follow the directions in the below graphic to insert MicroSD card properly:

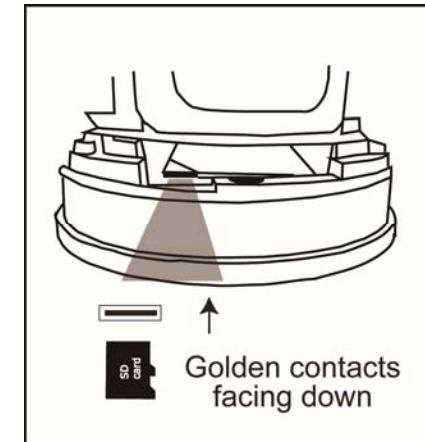

Camera Configuration

For advanced configuration of your camera, please be sure you have connected your camera to NVR as shown below:

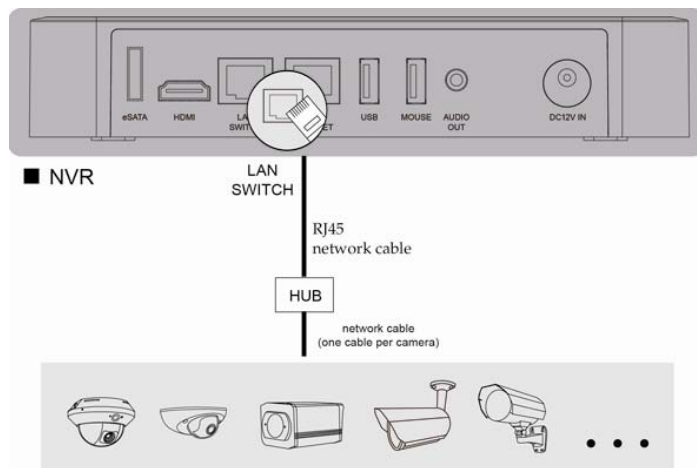

Step1: Connect PC to the HUB connected to your camera(s) with RJ45 network cable.

Step2: Search available devices with "IPScan.exe"; to download "IPScan.exe", please visit www.surveillance-download.com/user/IPscan.zip

Step3: After searching, set your PC in the same network segment as the specific camera you want to access, such as "192.168.30.xxx" (xxx could be 0~255) in our example

IP	Port	Type	Mac	
192.168.30.1	88	IP CAMERA (FIX)	00:19:94:25:78:4f	Configure
192.168.30.2	88	IP CAMERA (FIX)	00:18:94:25:77:4f	
192.168.30.1	88	IP CAMERA (FIX)	00:17:94:25:76:4f	Upgrade
192.168.30.4	88	IP CAMERA (FIX)	00:16:94:25:75:4f	Scan
192.168.30.5	88	IP CAMERA (FIX)	00:15:94:25:74:4f	
192.168.30.6	88	IP CAMERA (FIX)	00:14:94:25:73:4f	

Step4: Note down the IP address and port number of the camera you want to access, such as "192.168.30.1" and "88" in our example.

Step5: Open Internet Explorer on the PC, and enter the IP address and port number in the URL column to access the camera. The format is `http://ipaddress:portnum`, such as `http://192.168.30.1:88` in our example.